

User's Manual



Model : MP4-L50

Contents

Features.....
Precautions
Warning.....
Button & Function.....
Main Menu.....
Music Mode
Video Mode
Record Mode
Voice Mode
FM Radio Mode
Picture Mode
System Setting
Text Mode
Video Conversion Tool
Trouble Shooting

Features

- 1.8-inch TFT display
- 128 x 160 pixels display resolution
- Plays AVI (128x160), AMV video format files
- Plays MP3, WMA, WAV audio format files
- Picture browsing for JPEG format files
- Built in Micro-SD card slot, supports up to 8GB
- Built-in 300mAh Li-poly battery
- Built-in FM Radio
- Built-in game function
- Supports TXT E-book format
- Multi-language support

Precautions

Follow these tips to preserve the operational lifespan of your L50:

- It is recommended that you allow the battery to fully charge before using the device for the first time. Do not recharge unattended for longer than 4 hours.
- Do not hang the player by its earphones or cables
- Never force any cable connectors into the ports of your L50. Always make sure that your cable connectors are identical in shape and size before attempting to connect.
- When disconnecting your L50 from a computer, always use the Safely Remove Device function on your computer. Do not disconnect your digital media player while transmitting data.

Warning

- Do not use L50 in extreme temperatures. Keep away from extreme hot, cold, dry, or damp areas. Also keep away from water, fire, and radiation.
- Do not disassemble your L50
- Do not allow young children to use your player unsupervised.
- Do not install unauthorized software onto your L50.

Button & Controls

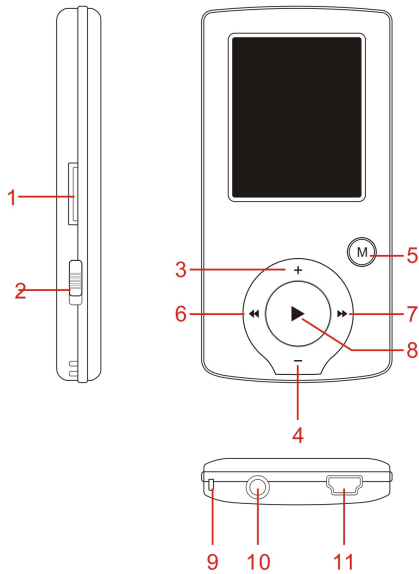

1. Micro SD card slot
2. ON/OFF power switch
3. VOL+
4. VOL-
5. Enter –short press,
Exit – long press
6. Last/ Backward
7. Next/Forward
8. Play/Pause、 Hold 3 second to power ON/ OFF L50
9. Hand strap Hole
10. Earphone socket
11. Mini USB socket

Basic Operation

Power On/Power off

Push [ON/OFF] button to On

Then press “[>II](play/stop)” button and hold 3 seconds to turn on and turn off the device.

Expansion Card

When Micro SD card (TF card) inserted into the Micro SD card slot. You can see the Card Folder in the menu. If no card, there is no Card Folder in the menu .

Charge/Connect/Disconnect from PC

Connect the device to PC via USB Cable to use it as a Removable Disk.

To charge t or disconnect L50 from PC, use the Safely Remove Device function on your computer

Main menu

Hold [M] button to enter main menu. Press [PRE] or [NEXT] to switch the modes.



Music

Select "Music" in the main menu

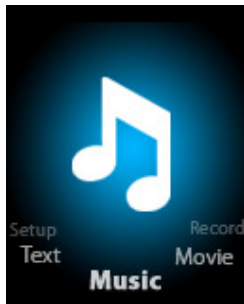

Press [M] button to confirm selection and then press PLAY/STOP [>II] button to play the song. While music playing, press [M] button to enter sub-menu:



While music playing, press [M] button to enter sub-menu:

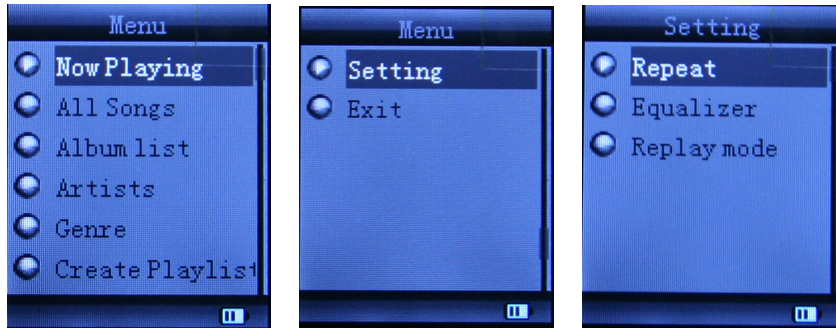

All Songs	Display all the songs		
Album list	Display the album		
Artists	Display the singer of the song		
Genre	Display the genre of the song		
Create Playlist	Create the playlist		
Setting	Repeat	Normal, Repeat one; Folder; Repeat Folder; Repeat All; Random; Intro.	
	Equalizer	NATURAL,ROCK,POP,CLASSIC,SOFT,JAZZ, DBB	
	Replay mode	Replay	A-B repeat, when "A" in the icon  blinks, swing [NEXT] to confirm start point, swing [NEXT] as "B" point . The player will replay from A to B according to the setting in the replay times. (Return to A-B replay mode by swing [PRE] button in such status)
		Replay times	Set how many times the A-B point replay Maximum is 10 times (1-10)
	Replay gap	set replay time gap between every replay	
Exit	Exit from sub-menu		

This device support Lyrics display. To fully display the contents of the song, you must make sure the name of the song under the music folder should be exactly the same one under LRC file.e.g You put a "song.mp3" in music folder, a same name "song.lrc" should be placed under LRC file.

Local folder	Indicate the folder of present playing file
Delete file	Delete the present playing song
Delete All	Delete All songs

If you want to delete a song while it is playing, press [>II] to stop playing, then press Mode button). select "Delete file", choose the file you want to delete, confirm "Delete", then the screen shows below:

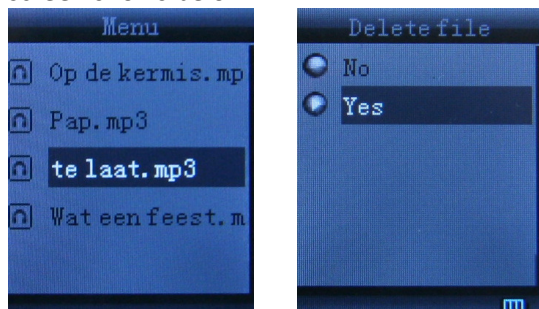

Movie

Select "Movie" in the main menu

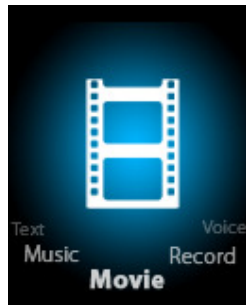

Press [M] button to confirm selection and then press PLAY/STOP [>II] button to play the video. While playing video, press [M] button to enter sub-menu.

All the operation is same as Music.

Please see **Video Conversion** section for how to load/convert video files to L50

Record Mode

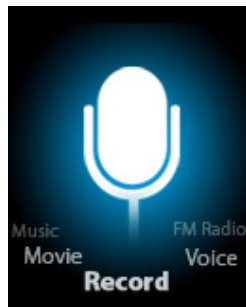

Press [M] button to select Record mode in main menu, then press [M] again enter into recording sub-menu. Press PLAY/STOP [>II] button to record and pause, long Press [M] to save current recording to file



Changing setting -when in Record mode, short press [M], to go into setting, long press [M] to exit setting

Local folder	Indicate the folder of present recording file
REC type:	32K BPS、 64K BPS、 128K BPS、 256K BPS
Exit	Exit form sub-menu

Noted that L50 supports 99 voice recording files storage in each directory. If the screen displays " Out of Space", which indicates the current directory has already saved 99 voice recording files, the user need to change to a new directory.

To playback the recorded files, please see Voice section

Voice

Press [PRE] or [NEXT] to select the Voice mode, then press [M] to confirm the selection, press [>II] to play the recording file.

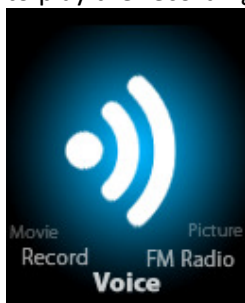

Press [>II] button to pause playback, swing [PRE] or [NEXT] button to select recording files.



Sub-menu while playing status:

Repeat
Replay mode
Exit

Sub-menu while stop status:

Local folder	Indicate the folder of present recording file
Delete	Delete recording song
Delete All	Delete all recording files
Exit	Exit from the sub-menu

FM mode

Earphone must be plugged in when access radio function

Select [PRE] or [NEXT] button to choose FM mode and press [ME] to confirm.

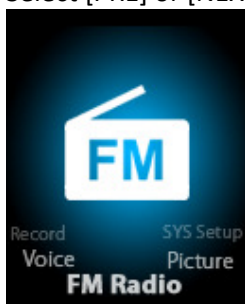

Press [>II] (play/stop) to save channel. If no channel is saved, you can look for channels by auto or manual searching. Press [M] again to get sub-menu as below:



Save	Save currently tuned frequency;
Record	Record current preset channel;
Delete	delete current preset channel;
Delete All	delete all saved channels;
Auto Search	Auto search FM channel
Normal Band	Frequencies from 87.5MHz---108MHz;
Exit	exit from FM sub-menu

Auto search: Holding [PRE] button or [NEXT] button for two seconds will tune frequency upward or downward until a radio station is located then it stop automatically.

Manual search: swing [PRE] or [NEXT] button to search channel upward or downward one-step

Notice: Normal band can store 20 preset channels respectively.

Picture

Select [PRE] or [NEXT] button to select Picture mode, then press [M] to confirm,

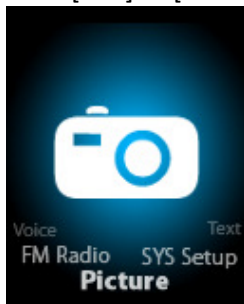

Press [M] button again to enter sub-menu:

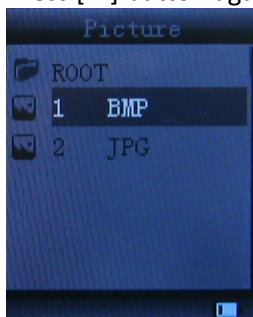

local folder	choose the folder where picture is saved;
playback set	manual play or auto play(there is a time gap for auto play from 1-10 seconds)
Delete file	Delete picture;

Delete All	Delete all pictures
Exit	Exit from sub-menu

Press [>II] (play/stop) button to display the picture automatically or manually according to previous playing setting.

Note: maximum resolution for jpg files picture is 1280 x1024, might need to lower resolution jpg files if L50 displaying "format error"

SYS Setup

Select [PRE] or [NEXT] button to select SYS Setup, then press [M] to confirm,

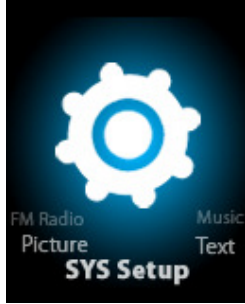

Press [M] button again to enter sub-menu:

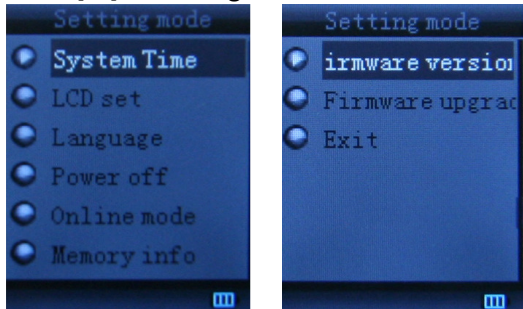

Record time	Press [M] to edit recording time. Swing [NEXT] button and the digit of year will increase; swing [VOL+] button to edit next digit, push [PRE] or [NEXT] button to adjust the digit. Press [M] to confirm the setting
Main Style	Blue、 Green 、 Orange、 Pink、 Red、 Yellow
LCD set	Always light 10 Sec 20 Sec 30 Sec
Language	Simple Chinese, English, Trad Chinese, Japanese, French, German, Italian, Dutch, Portuguese, Spanish, Swedish, Czech, Denmark, Polish etc.
Power off	Off time: set self-power off time when the player is stopped and no button is pressed. The time unit is seconds. 0 means set off the function. Sleep time: set self-power off time after last key pressed, regardless of whether the player is active or stopped. The time unit is minutes.
Online mode	Multi Drive; Normal only; Encrypted only
Memory info.	Check the memory size and the remaining memory
Firmware version	Display the player's firmware version
Firmware upgrade	Firmware can be upgraded via connection to PC
Exit	Exit from the sub-menu

TEXT

Select [PRE] or [NEXT] button to select Text, then press [M] to confirm,

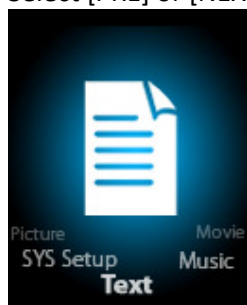

Enter TEXT mode by pressing Mode button, then you can read and edit the article in the device. The device only can recognize the article in “txt.” file format.

Press [M] button again to enter sub-menu:

local folder	choose the folder where picture is saved;
playback set	manual play or auto play(there is a time gap for auto play from 1-10 seconds)
Delete file	Delete picture;
Delete all	Delete all pictures
Exit	Exit from sub-menu

Video Conversion

Please follow the steps here below to install the video conversion tool.

Please make sure you have installed Windows media player 9.exe and Directx9.0 before you start.

Put CD drive into computer and open the drive →Run Setup.exe to install the software, then restart the computer→ Choose menu: start-----program-----Media Player Utilities --- AMV/AVI Converter → There's a window appears, choose the file you want to convert, then choose the folder you want to put the new converted file, click “Begin”

some AVI files download from website might need to use the Conversion Tool to reduce the resolution, so C50 can playback

Trouble Shooting

No power	Check battery level.
	Recharge as per directions in User Manual
Unable to locate or play files	Check that the file is in a compatible format, and right resolution
	Check to see if the file is stored in a different directory.
No music is heard in the earphones	Check the volume level
	Check the connection (earphone to the earphone jack)
	Check if your music file is compatible with your MP3 player.

Not charging	Check to make sure that your L50 is connected to a USB port on your computer.
Unable to download music.	Check if you have enough space on your to download the music file.
	Check to make sure that the USB cable is connected to the PC and to the Digital Media Player.
Computer not recognizing L50	Check that the USB cable is properly connected to your computer.
	Please try another USB cable or another USB port on the PC

For more FAQ please visit : www.LaserCo.net, or email to support@LaserCo.net